



DVP855 DVD Player

User's Guide



7835 E. McClain Drive
Scottsdale, AZ 85260
www.sonicblue.com



GO.VIDEO

DP00-L0021M

Introduction

Safety Precautions



The lightning flash with arrowhead symbol, within an equilateral triangle, is intended to alert the user to the presence of uninsulated 'dangerous voltage' within the product's enclosure that may be of sufficient magnitude to constitute a risk of electric shock to persons.



The exclamation point within an equilateral triangle is intended to alert the user to the presence of important-operating and maintenance (servicing) instructions in the literature accompanying the appliance.

WARNING | TO REDUCE THE RISK OF FIRE OR ELECTRIC SHOCK, DO NOT EXPOSE THIS PRODUCT TO RAIN OR MOISTURE.

CAUTION | TO PREVENT ELECTRIC SHOCK, MATCH WIDE BLADE OF PLUG TO WIDE SLOT, FULLY INSERT.

ATTENTION | POUR EVITER LES CHOC ELECTRIQUE, INTRODUIRE LA LAME LA PLUS LARGE DE LA FICHE DANS LA BORNE CORRESPONDANTE DE LA PRISE ET POUSSER JUSQU'AU FOND.

CAUTION | This Digital Video Disc Player employs a Laser System. To ensure proper use of this product, please read this owner's manual carefully and retain for future reference, should the unit require maintenance, contact an authorised service location-see service procedure. Use of controls, adjustments or the performance of procedures other than those specified may result herein hazardous radiation exposure. To prevent direct exposure to laser beam, do not try to open the enclosure. Visible laser radiation when open the enclosure. DO NOT STARE INTO BEAM.

FCC NOTICE | This equipment has been tested and found to comply with the limits for a Class B digital device, pursuant to part 15 of the FCC Rules. These limits are designed to provide reasonable protection against harmful interference in a residential installation. This equipment generates, uses, and can radiate radio frequency energy and, if not installed and used in accordance with the instructions, may cause harmful interference to radio communications. However, there is no guarantee that interference will not occur in a particular installation. If this equipment does cause harmful interference to radio or television reception, which can be determined by turning the equipment off and on, the user is encouraged to try to correct the interference by one or more of the following measures:

- Reorient or relocate the receiving antenna.
- Increase the separation between the equipment and receiver.
- Connect the equipment into an outlet on a circuit different from that to which the receiver is connected.
- Consult the dealer or an experienced radio/TV technician for help.

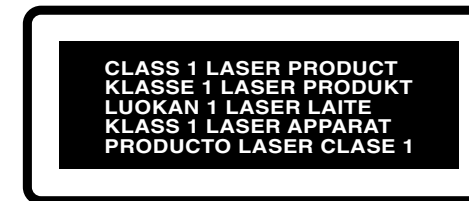

FCC WARNING | Changes or modifications not expressly approved by the party responsible for compliance could void the user's authority to operate the equipment.

INDUSTRY CANADA REQUIREMENT

This class B digital apparatus meets all requirements of the Canadian Interference-Causing Equipment Regulations. Cet appareil numérique de la classe B respecte toutes les exigences du Règlement sur le matériel brouilleur du Canada.

DTS

"DTS" and "DTS Digital Out" are trademarks of Digital Theater Systems, Inc.

RECORD YOUR MODEL NUMBER (Now, while) you can see it)
The model and serial number of your new DVD player are located on the back of the DVD player cabinet. For your future convenience, we suggest that you record these numbers here:

MODEL NO. _____

SERIAL NO. _____

Introduction

Important Safety Instructions

CAUTION PLEASE READ AND OBSERVE ALL WARNINGS AND INSTRUCTIONS IN THIS OWNER'S MANUAL AND THOSE MARKED ON THE UNIT, RETAIN THIS BOOKLET FOR FUTURE REFERENCE.

This set has been designed and manufactured to assure personal safety.

Improper use can result in electric shock or fire hazard. The safeguards incorporated in this unit will protect you if you observe the following procedures for installation, use and servicing.

This unit is fully transistorized and does not contain any parts that can be repaired by the user.

DO NOT REMOVE THE CABINET COVER, OR YOU MAY BE EXPOSED TO DANGEROUS VOLTAGE. REFER SERVICING TO QUALIFIED SERVICE PERSONNEL ONLY.

1. Read owner's manual

After unpacking this product, read the owner's manual carefully, and follow all the operating and other instructions.

2. Power Sources

This product should be operated only from the type of power source indicated on the marking label. If you are not sure of the type of power supply in your home, consult your product dealer or local power company. For products intended to operate from battery power, or other sources, refer to the operating instructions.

3. Grounding or Polarisation

This product is equipped with a polarised alternating current line plug (a plug having one blade wider than the other). This plug will fit into the power outlet only one way. This is a safety feature. If you are unable to insert the plug fully into the outlet, try reversing the plug. If the plug should still fail to fit, contact your electrician to replace your obsolete outlet. Do not defeat the safety purpose of the polarised plug.

4. Ventilation

Slots and openings in the cabinet are provided for ventilation and to ensure reliable operation of the product and to protect it from overheating. These openings must not be blocked or covered. The openings should never be blocked by placing the product on a bed, sofa, rug or other similar surface. This product should not be placed in a built-in installation such as a bookcase or rack unless proper ventilation is provided or the manufacturer's instructions have been adhered to.

5. Heat

The product should be situated away from heat sources such as radiators, heat registers, stoves, or other products (including amplifiers) that produce heat.

6. Water and Moisture

Do not use this product near water—for example, near a bath tub, wash bowl, kitchen sink, or laundry tub; in a wet basement; or near a swimming pool and the like.

7. Cleaning

Unplug this product from the wall outlet before cleaning. Do not use liquid cleaners or aerosol cleaners. Use a damp cloth for cleaning.

8. Power-Cord Protection

Power-supply cords should be routed so that they are not likely to be walked on or pinched by items placed upon or against them, paying particular attention to cords at plugs, convenience receptacles, and the point where they exit from the product.

9. Overloading

Do not overload wall outlets, extension cords, or integral convenience receptacles as this can result in a risk of fire or electric shock.

10. Lightning

For added protection of this product during storms, or when it is left unattended and unused for long periods of time, unplug it from the wall outlet. This will prevent damage to the product due to lightning and power-line surges.

11. Object and Liquid Entry

Never push objects of any kind into this product through openings as they may touch dangerous voltage points or short-out parts that could result in a fire or electric shock. Never spill liquid of any kind on the product.

12. Attachments.

Do not use attachments not recommended by the product manufacturer as they may cause hazards.

13. Accessories

Do not place this product on an unstable cart, stand, tripod, bracket, or table. The product may fall, causing serious injury to a child or adult, and serious damage to the product. Use only with a cart, stand, tripod, bracket, or table recommended by the manufacturer, or sold with the product. Any mounting of the product should follow the manufacturer's instructions, and should use a mounting accessory recommended by the manufacturer. A product and cart combination should be moved with care. Quick stops, excessive force, and uneven surfaces may cause the product and cart combination to overturn.



14. Disc Tray

Keep your fingers well clear of the disc tray as it is closing. It may cause serious personal injury.

15. Burden

Do not place a heavy object on or step on the product. The object may fall, causing serious personal injury and serious damage to the product.

16. Connecting

When you connect the product to other equipment, turn off the power and unplug all of the equipment from the wall outlet. Failure to do so may cause an electric shock and serious personal injury. Read the owner's manual of the other equipment carefully and follow the instructions when making any connections.

17. Sound Volume

Reduce the volume to the minimum level before you turn on the product. Otherwise, sudden high volume sound may cause hearing or speaker damage.

18. Sound Distortion

Do not allow the product to output distorted sound for a long time. It may cause speaker overheating and fire.

19. Headphones

When you use the headphones, keep the volume at a moderate level. If you use the headphones continuously with high volume sound, it may cause hearing damage.

20. Laser Beam

Do not look into the opening of the disc tray or ventilation opening of the product to see to source of the laser beam. It may cause sight damage.

21. Disc

Do not use a cracked, deformed, or repaired disc. These discs are easily broken and may cause serious personal injury and product malfunction.

22. Damage Requiring Service

Unplug this product from the wall outlet and refer servicing to qualified service personnel under the following conditions:

- When the power-supply cord or plug is damaged.
- If liquid has been spilled, or objects have fallen into the product.
- If the product has been exposed to rain or water.
- If the product does not operate normally by following the operating instructions. Adjust only those controls that are covered by the operating instructions as an improper adjustment of other controls may result in damage and will often require extensive work by a qualified technician to restore the product to its normal operation.
- If the product has been dropped or damaged in any way.
- When the product exhibits a distinct change in performance—this indicates a need for service.

23. Servicing

Do not attempt to service this product yourself as opening or removing covers may expose you to dangerous voltage or other hazards. Refer all servicing to qualified service personnel.

24. Replacement parts

When replacement parts are required, be sure the service technician has used replacement parts specified by the manufacturer or have the same characteristics as the original part. Unauthorised substitutions may result in fire, electric shock, or other hazards.

25. Safety Check

Upon completion of any service or repairs to this product, ask the service technician to perform safety checks to determine that the product is in proper operating condition.

Introduction

Precautions

Notes on handling

- When shipping the DVD player, always use the original shipping carton and packing materials. For maximum protection, repack the unit as it was originally packed at the factory.
- Do not use volatile liquids, such as insect spray, near the DVD player. Do not leave rubber or plastic products in contact with the DVD player for a long time. They will leave marks on the finish.
- The top and rear panels of the DVD player may become warm after a long period of use. This is normal and not a malfunction.
- When the DVD player is not in use, be sure to remove the disc and turn off the power.
- If you do not use the DVD player for a long period, the unit may not function properly in the future. Turn on and use the DVD player occasionally.

Notes on Locating

- When you place this DVD player near a TV, radio, or VCR, the playback picture may become poor and the sound may be distorted. In this case, move the DVD player away from the TV, radio, or VCR.

Notes on Cleaning

Use a soft, dry cloth for cleaning.

- For stubborn dirt, soak the cloth in a weak detergent solution, wring well and wipe. Use a dry cloth to wipe it dry. Do not use any type of solvent, such as thinner and benzene, as they may damage the surface of the DVD player.
- If you use a chemical saturated cloth to clean the unit, allow that product's instructions.

Warning : Cleaning and adjustment of lenses and/or other components of playback mechanism should be performed by a qualified service technician.

To Obtain a Clear Picture

The DVD player is a high technology, precision device. If the optical pick-up lens and disc drive parts are dirty or worn down, the picture quality becomes poor. To obtain a clear picture, we recommend regular inspection and maintenance (cleaning or parts replacement) every 1,000 hours of use depending on the operating environment. For details, contact your nearest dealer.

Notes on Moisture Condensation

Moisture condensation damages the DVD player. Please read the following carefully.

Moisture condensation occurs, for example, when you pour a cold drink into a glass on a warm day. Drops of water form on the outside of the glass. In the same way, moisture may condense on the optical pick-up lens inside this unit, one of the most crucial internal parts of the DVD player.

Moisture condensation occurs during the following cases.

- When you bring the DVD player directly from a cold place to a warm place.
- When you use the DVD player in a room where you just turned on the heater, or a place where the cold wind from the air conditioner directly hits the unit.
- In summer, when you use the DVD player in a hot and humid place just after you move the unit from an air conditioned room.
- When you use the DVD player in a humid place.

Do not use the DVD player when moisture condensation may occur.

If you use the DVD player in such a situation, it may damage discs and internal parts. Remove the disc, connect the power cord of the DVD player to the wall outlet, turn on the DVD player and leave it "ON" for two or three hours. After two or three hours, the DVD player will have warmed up and evaporated any moisture. Keep the DVD player connected to the wall outlet and moisture condensation will seldom occur.

Notes on Discs

This section shows you how to handle, clean, and store discs.

On Handling Discs

- Do not touch the playback side of the disc.

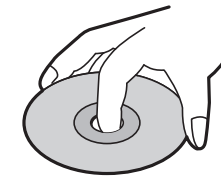

- Do not attach paper or tape to discs.



On Storing Discs

- Do not store discs in a place subject to direct sunlight or near heat sources.
- Do not store discs in places subject to moisture and dust such as a bathroom or near a humidifier.
- Store discs vertically in a case. Stacking or placing objects on discs outside of their case may cause warping.

On Cleaning discs

- Fingerprints and dust on the disc cause picture and sound deterioration. Wipe the disc from the center outward with a soft cloth. Always keep the disc clean.
- If you cannot wipe off the dust with a soft cloth, wipe the disc lightly with a slightly moistened soft cloth and finish with a dry cloth.
- Do not use any type of solvents such as thinner, benzene, commercially available cleaners or anti-static spray for vinyl LPs. They may damage the disc.

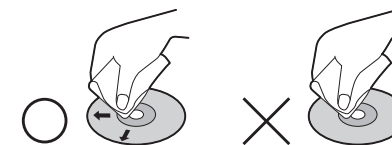



About This Owner's Manual

- This owner's manual explains the basic instructions of this DVD player.
- Some DVD video discs have functions that may not be explained in this owner's manual. Therefore, some instructions may differ from this owner's manual, and there may be extra instructions. In this case, follow the instructions displayed on the TV screen or package.
- "⊗" or "⊕" may appear on the TV screen during operation. This icon means the function explained in this owner's manual is not available on that specific DVD video disc.

Playable Discs

This DVD player can play back the following discs.

	Disc mark	Contents	Disc size	Maximum playback time
DVD video discs		Audio+Video (moving pictures)	12 cm	Approx. 4 hours (single sided disc)
				Approx. 8 hours (double sided disc)
			8 cm	Approx. 80 minutes (single sided disc)
				Approx. 160 minutes (double sided disc)
Audio CDs		Audio	12 cm	74 minutes
			8 cm	20 minutes
Video CDs		Audio+Video (moving pictures)	12 cm	74 minutes
			8 cm	20 minutes

You cannot playback discs other than those listed above. (CD-ROM, CD-G, photo CD, and CD-i discs can not be played on this DVD player.)

Region Management Information

Region Management Information: This DVD Player is designed and manufactured to respond to the Region Management Information that is recorded on a DVD disc. If the Region number described on the DVD disc does not correspond to the Region number of this DVD player, this DVD player cannot play that disc.

The Region number of this DVD player is.



(USA/CANADA)

Notes on Unauthorized Discs

You may not be able to play back some DVD video discs on this player if they were purchased from outside your geographic area or made for business purposes.

When you try to play back an unauthorized disc, "Check Regional Code" appears on the TV screen.

Notes on Copyright

It is forbidden by law to copy, broadcast, show, broadcast on cable, play in public, and rent copyrighted material without permission.

DVD video discs are copy protected, and any recordings made from these discs will be distorted.

This product incorporates copyright protection technology that is protected by method claims of certain U.S. patents and other intellectual property rights owned by Macrovision Corporation and other rights owners. Use of this copyright protection technology must be authorized by Macrovision Corporation, and is intended for home and other limited viewing uses only, unless otherwise authorized by Macrovision Corporation. Reverse engineering or disassembly is prohibited.

• Introduction	1
• Disc Requirements/Copyright Information	7
• Front Panel & Display	9
• Rear Panel	10
• Remote Control	11

• Connecting to a TV	13
• Connecting to an audio system	
- Connecting to a 2CH amplifier	14
- Connecting to an DIGITAL amplifier	15

• Basic Playback	16
• Displaying the playback status	17
• Searching for a specific screen/song during playback	18
• Setting a custom view	20
• Changing the audio/subtitle language	22
• Changing the size and angle of the screen	23

• Using the setup menu	26
• Setting the language	27
• Setting the VIDEO	29
• Setting the SPEAKER	30
• Setting the AUDIO	31
• CUSTOM settings	32
• Setting rating level and password	33

• Operation with a MP3 disc	34
• Accessories	35
• Troubleshooting Guide	38
• Specifications	39

Front Panel & Display

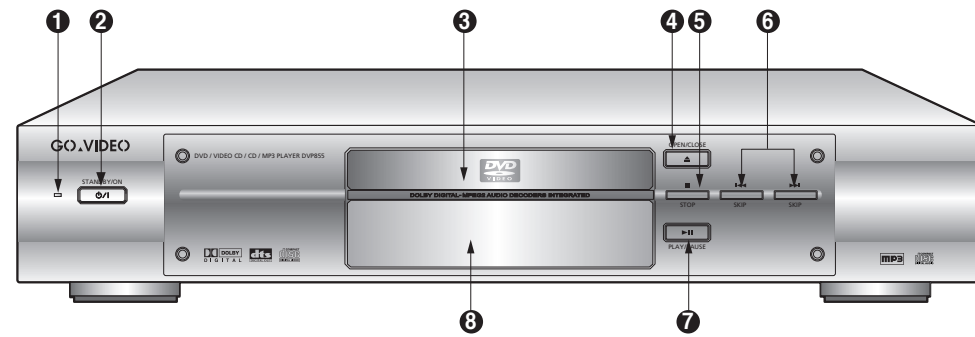

Front Panel

- 1 Standby LED
- 2 Power button
- 3 Disc tray
- 4 Tray open/close button
- 5 Stop button
- 6 Chapter, track skip button
- 7 Playback/Pause button
- 8 Display window

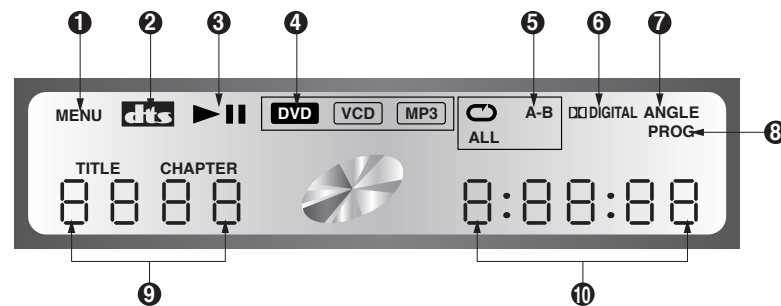

VFD Display

- 1 Menu display
- 2 DTS output display
- 3 Playback/Pause display
- 4 Disc type display
- 5 Repeat playback display
- 6 DOLBY DIGITAL sound display
- 7 Frame angle display
- 8 VIDEO/AUDIO/TRACK program display
- 9 Title/chapter display
- 10 Track message display

Rear Panel

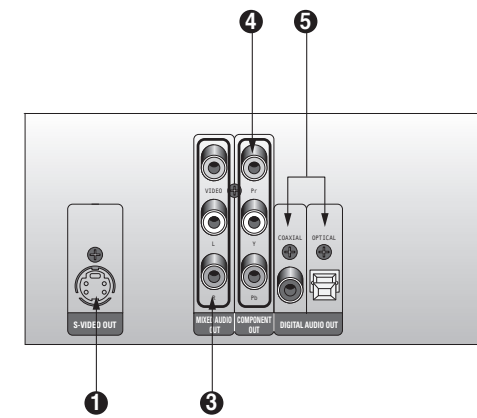

Rear Panel

- 1 S-VIDEO OUTPUT TERMINAL
Connection with a TV that has an S- video input terminal
- 3 MIXED AUDIO/VIDEO OUTPUT TERMINAL
Connection with a TV video input terminal
- 4 COMPONENT VIDEO OUT TERMINAL
Connection with a TV that has a component video input terminal.
- 5 DIGITAL AUDIO OUTPUT TERMINAL
Connection with a dolby digital amplifier

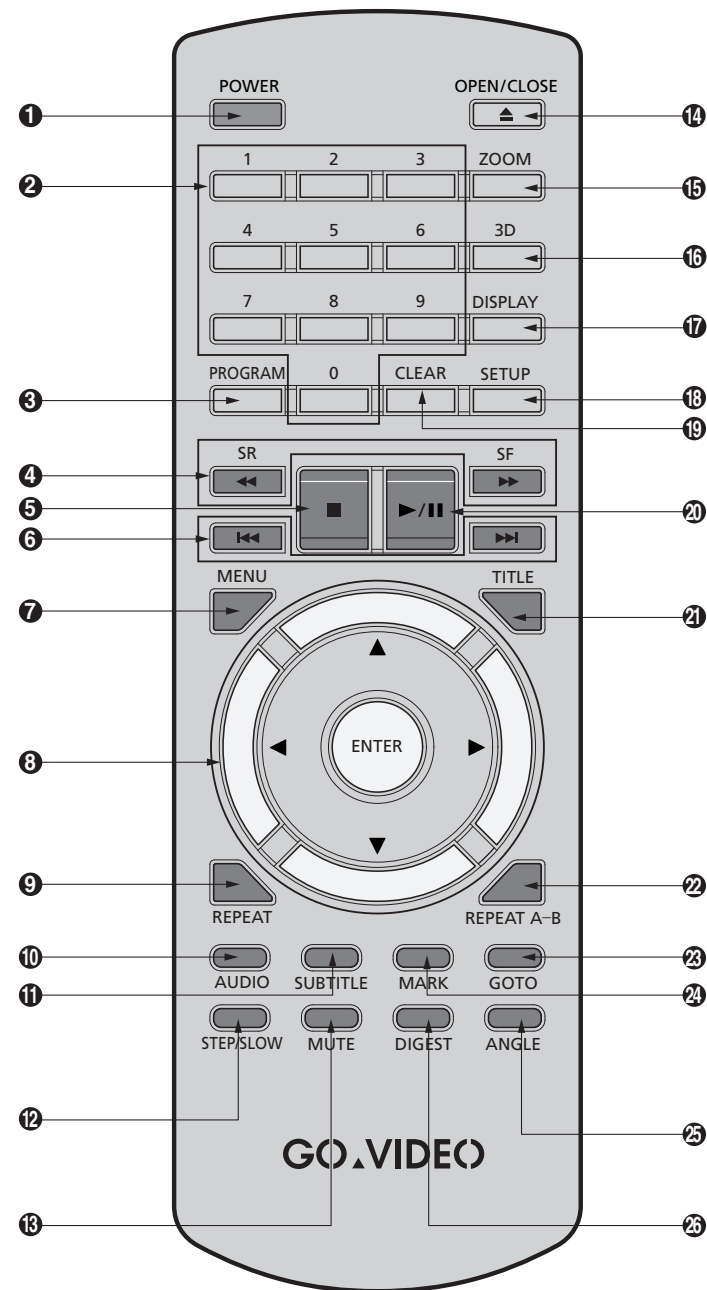

- ❶ **POWER button**
- ❷ **NUMBER button**
- ❸ **PROGRAM button**
 - For playback in a specified order
- ❹ **SCAN/SLOW button**
 - For fast and slow playback
- ❺ **STOP button**
- ❻ **SKIP button**
 - For skipping to the next chapter or song track
- ❼ **MENU button**
 - For displaying the menu contained in the disc
- ❽ **Arrow button**
 - For selecting and executing setup, menu
- ❾ **REPEAT button**
 - For repeated playback of disc title, chapter, song track
- ❿ **AUDIO button**
 - For selecting the audio language
- ⓫ **SUBTITLE button**
 - For selecting the subtitle language
- ⓬ **STEP/SLOW button**
 - For playing one frame at a time or slow playback
- ⓭ **MUTE button**
- ⓮ **OPEN/CLOSE button**
- ⓯ **Zoom button**
 - For magnifying the screen
- ⓰ **3D button**
 - For stereophonic sound effect
- ⓱ **DISPLAY button**
 - For checking the current disc status
- ⓲ **SETUP button**
 - For initial settings
- ⓳ **CLEAR button**
 - To erase a program content
- ⓴ **PLAYBACK/PAUSE button**
- ⓵ **TITLE button**
 - For selecting a title listed in the disc
- ⓶ **REPEAT A-B button**
 - For specifying and repeating playback of a section
- ⓷ **GOTO button**
 - For moving to a specified location
- ⓸ **MARK button**
 - For saving and viewing a specified frame
- ⓹ **ANGLE button**
 - For viewing with a different frame angle
- ⓺ **DIGEST button**
 - For previewing the contents of each track on a VCD

NOTE

- symbol displayed on the screen when a button is pressed on the remote controller means that function is inactive for the disc that is currently being played.

Connecting to a TV

Turn the power off to the DVD, TV and audio equipment before connecting any cables.

Connecting only to TV

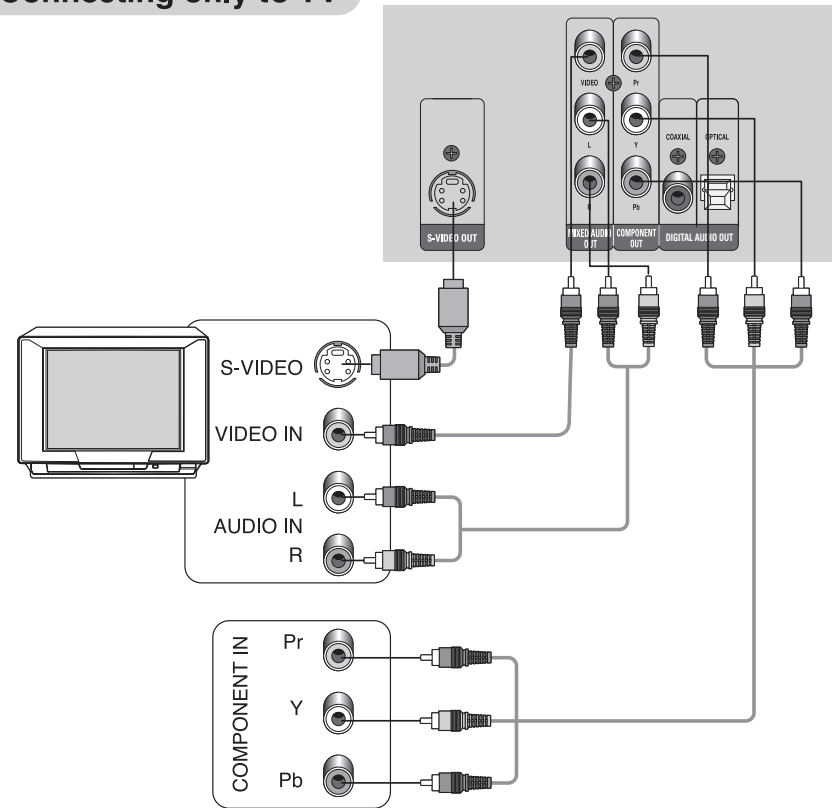

S-VIDEO OUT SOCKET

- Connect the TV S-VIDEO video input terminal and the DVD S-VIDEO video terminal with any S-VIDEO CABLE. For S-VIDEO connection, switch the TV to S-VIDEO mode.

MIXED AUDIO OUT SOCKET

- Connect the video output terminal with the TV video input terminal. Before connection, switch the TV to VIDEO mode.
- Connect the left and right audio output terminal to the left and right TV audio input terminals, respectively.

COMPONENT OUT SOCKET

- Connect the Pr, Y, Pb terminals to the TV Pr, Y, Pb terminals.
- To connect using the COMPONENT OUT terminal, switch the TV to Pr, Y, Pb. This is used to view video at the highest quality

NOTE

- Do not connect the Pr, Y, Pb terminals when connecting the S-VIDEO terminal and vice versa.

Connecting to an audio system

Connecting to a 2CH amplifier

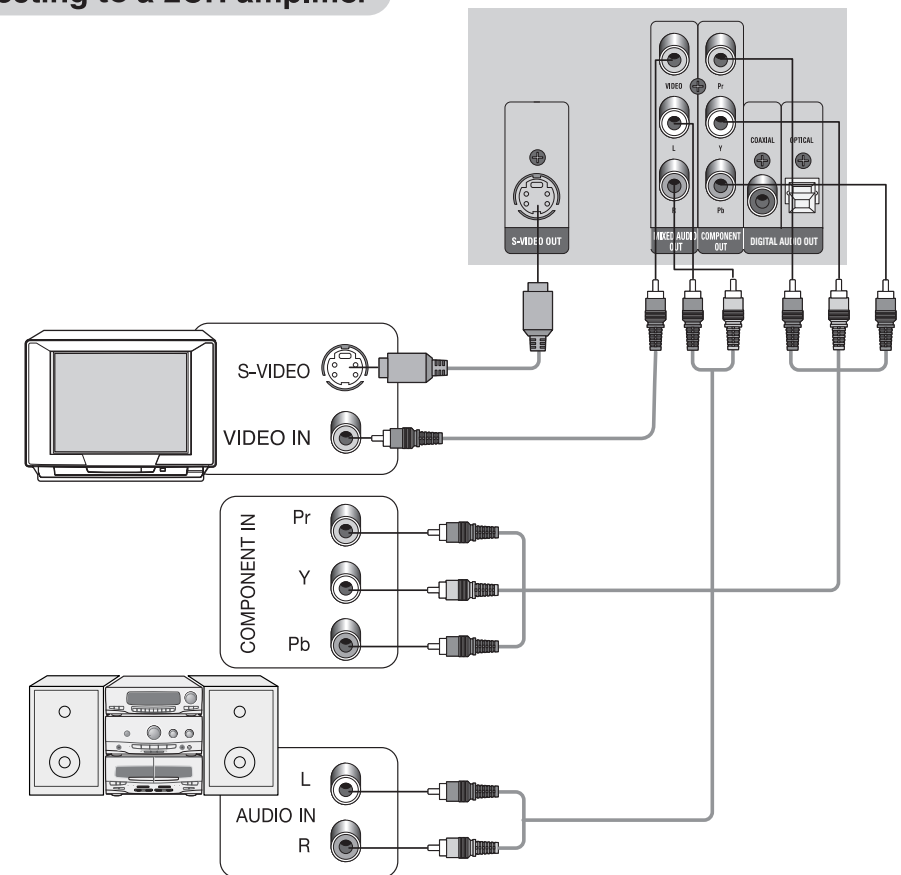

S-VIDEO OUT SOCKET

- Connect the TV S-VIDEO video input terminal with the DVD S-VIDEO video terminal using an S-VIDEO CABLE. For S-VIDEO connection, switch the TV to S-VIDEO mode.

MIXED AUDIO OUT SOCKET

- Connect the video output terminal with the TV video input terminal. For video output connection, switch the TV to VIDEO mode.
- Connect the left and right audio output terminals with the left and right audio input terminals of the audio system, respectively.

COMPONENT OUT SOCKET

- Connect the TV Pr, Y, Pb terminals to the DVD Pr, Y, Pb terminals.

Connecting to an DIGITAL amplifier

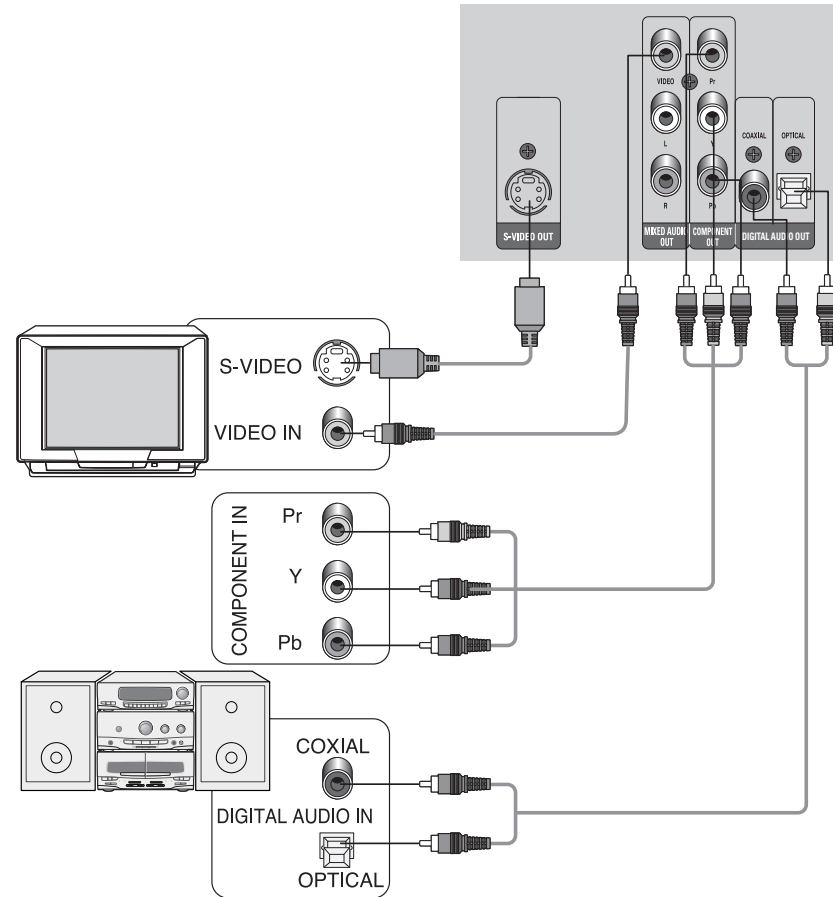

S-VIDEO OUT SOCKET

- Connect the TV S-VIDEO video input terminal with the DVD S-VIDEO video terminal using an S-VIDEO CABLE. For S-VIDEO connection, switch the TV to S-VIDEO mode.

MIXED AUDIO OUT SOCKET

- Connect the video output terminal with the TV video input terminal. For video output connection, switch the TV to VIDEO mode.

COMPONENT OUT SOCKET

- Connect the TV Pr, Y, Pb terminals with the DVD Pr, Y, Pb terminals.

DIGITAL AUDIO OUT SOCKET

- Connect the OPTICAL or COAXIAL terminals with their respective terminals of an amplifier that supports Dolby digital/DTS.

When you connect DVD player to TV and turn it on and if you find that colors are lost and the screen waves, open the door of DVD player and press "DISPLAY" button until a clear scene appears.

Before operating

- Turn on the TV and select the VIDEO input source connected to the DVD player pressing the TV/VIDEO select button. If the S-VIDEO is connected, select the S-VIDEO mode.
- Turn on the audio system and select the input source connected to the DVD Player.
- When the DVD is turned on, the DVD SCREEN will appear.
- Set the initial settings according to the desired language, audio or the connected TV or audio system. Turn to instructions on initial setting on page 26 for more details.

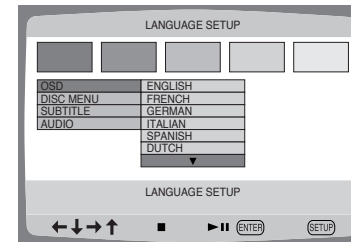

Playback

- 1 Open the tray by pressing OPEN/CLOSE button.
- 2 Place a disc properly on the tray with the playback side down.
- 3 Close the tray by pressing OPEN/CLOSE button.
 - To STOP PLAYBACK, press STOP button.
 - To temporarily STOP PLAYBACK, press the PLAYBACK/PAUSE button.
 - To resume PLAYBACK, press the PLAYBACK/PAUSE button once again.

NOTE

- The DVD player automatically memorizes the location where the stop button was pressed during playback and resumes from that point when the playback button is pressed again.
- Playback is stopped after 10 minutes have passed in the pause state. After a minute from the moment playback is stopped, the screen oscillates between dark and light shades to protect the TV hardware. And after 10 minutes, the power is automatically turned off.

Displaying the playback status

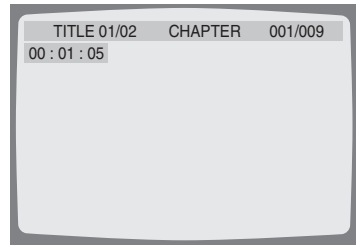

For DVD Playback

1 Press DISPLAY button on the remote controller.

- The title, chapter number and the time elapsed is shown.
- Pressing the button again shows the remaining time.
- Pressing the button again shows the time elapsed for the chapter.
- Pressing the button again shows the remaining time for the chapter.
- Pressing the button again exits from the playback state reference.

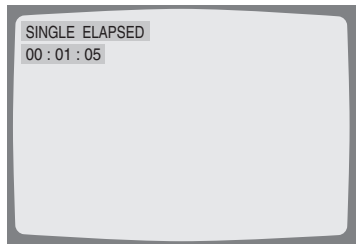

CD/VCD version 2.0 PBC OFF mode and VCD version 1.1 playback

1 Press DISPLAY button on the remote controller.

- The elapsed time for the title being played is shown.
- Pressing the button again shows the remaining time for the track.
- Pressing the button again shows the total playback elapsed time.
- Pressing the button again shows the total remaining time.
- Pressing the button again exits from the playback state reference.

VCD version 2.0 PBC ON mode playback

1 Press DISPLAY button on the remote controller.

- The elapsed time for the title being played is shown.
- Pressing the button again shows the remaining time for the track.
- Pressing the button again exits from the playback state reference.

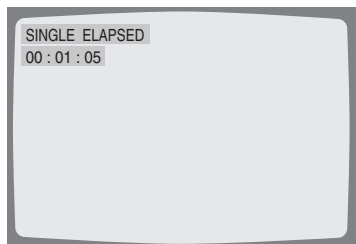

Searching for a specific screen/song during playback

You can use one of the functions listed below in order to jump to a specific chapter or track during playback.

Scan fast forward or fast reverse

1 Press ◀ or ▶ button on the remote controller.

- For DVD playback, pressing the button successively executes the function in the following order : 2X → 4X → 8X → 16X
32X → 64X → normal playback.
- For VCD playback, the order is 2X → 4X
8X → 16X → 32X → normal playback.
- For CD playback, the order is FAST → normal playback.
- To return to normal playback speed, press the ▶/|| button.

To skip a chapter or a track

1 Press ◀◀ or ▶▶ button on the remote controller.

- When the ▶▶ button is pressed, playback skips over to the next chapter for DVD playback and the next track for VCD version 2.0 menu OFF mode, version 1.1 and CD playback. For a VCD that contains a single track, playback skips forward at 5 minute intervals.
- When the ◀◀ button pressed, playback skips over to the beginning of the current chapter for DVD playback and the previous chapter when it is pressed again. For a VCD that contains a single track, playback skips backward at 5 minute intervals.

NOTE

- What is a chapter?
A chapter is one of the several sections to which a movie is divided into.
- What is a title?
A title refers to a single whole movie.

To view frame by frame

1 Press STEP/SLOW button on the remote controller

- The picture advances one frame at a time each time the button is pressed.
- To return to normal PLAYBACK, press the PLAYBACK/PAUSE button.
- This function is not activated for CD PLAYBACK.

To play backwards or forwards in slow motion

1 Press STEP/SLOW button on the remote controller

2 Press ►► or ◀◀ button.

- For DVD playback, each successive press of the button executes the function in the following order : 1/2X → 1/4X → 1/8X.
- For VCD playback, the order is 1/2X → 1/4X → 1/8X and the SR button is inactivated.
To return to normal PLAYBACK, press the PLAYBACK/PAUSE button.
- This function is not activated for CD PLAYBACK.

NOTE

- No sound is heard during fast/slow/frame-by-frame PLAYBACK. However, sound is heard during FAST CD PLAYBACK.

Setting a specific DVD title or chapter

1 Press GOTO button on the remote controller.

- Go to the title or chapter using the arrow buttons(◀/▶).
- Press the number of the title or chapter and then press Enter button.

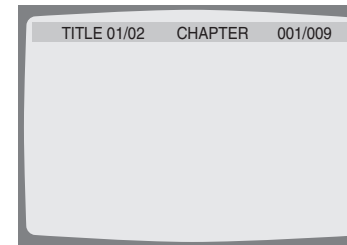

Setting a specific frame within a chapter of a DVD

1 Press GOTO button on the remote controller twice.

- Set the time location of the frame using the number buttons and then press Enter.

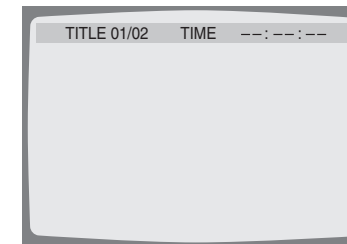

NOTE

- This function does not work in a title which contains multiple camera angles in its track.

Setting a VCD

1 Press GOTO button on the remote controller.

- Press the specific location using the number buttons.



Setting a custom view

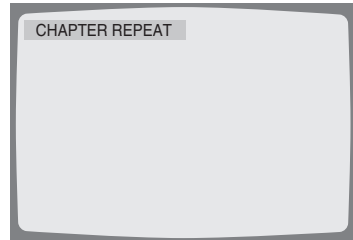

Repeat playback

This function repeats the playback of a chapter, title or track.

1 Press REPEAT button on the remote controller.

- Pressing the button successively for a DVD executes the function in the following order: CHAPTER REPEAT → TITLE REPEAT → REPEAT OFF.
- For CD/VCD, the order is REPEAT TRACK → REPEAT DISC → REPEAT OFF.

Chapter repeat : Repeats playback of a single chapter.
Title repeat : Repeats playback of a single title.
Repeat off : Exits from repeat mode.
Repeat track : Repeats playback of a single track.
Repeat disc : Repeats playback of the whole disc.

Repeat playback of a specified section

1 Pressing REPEAT A-B button selects the beginning(A) of the repeated playback section and pressing it again selects the end(B).

- Only the specified section is repeatedly played back.
- Pressing the button again returns to normal playback.

NOTE

- Repeated playback is executed for a title or chapter in the case of DVD playback and disc or track for CD/VCD playback.
- This function may not work for some discs.
- Press Repeat A-B button before the next title or track begins. Otherwise, the setting is cancelled.
- This function does not work in a title which contains multiple camera angles in its track.

Changing the audio/subtitle language

Select the language or discs that contain more than one language by following the instructions below.

Changing the audio language

1 Press AUDIO button on the remote controller

- For a DVD, select one of the languages by successively pressing the button.
- For a CD/VCD, select either STEREO, MONO LEFT or MONO RIGHT by successively pressing the button.

Changing the subtitle language

1 Press SUBTITLE button on the remote controller.

- Select one of the languages by successively pressing the button.
- This function is not activated for a CD/VCD.

NOTE

- The AUDIO, SUBTITLE functions may not work for some discs.

Viewing the first frame of each track

1 Press DIGEST button on the remote controller.

- Press this button shows the first frame of each track and select one of the frames, then it playback from that track.
- This function only works for VCD version 2.0 menu off mode or VCD version 1.1.
- In case more than 9 tracks, It is several pages.
- Use SKIP button(▶▶, ◀◀) for movement between pages.

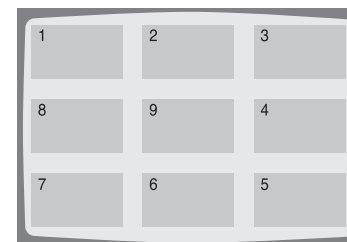

Changing the size of the screen

1 Press ZOOM button

- Pressing the button successively executes the function in the following order :
ZOOMX1.5 → X2 → X4 → OFF
- This function is activated only for DVD/VCD playback.

Viewing from another angle

1 Press ANGLE button

- Pressing the button successively changes the viewing angle which is displayed on the screen.
- This function is activated for only discs having scenes recorded at different angles.

Saving a specific frame in memory

1 Press MARK button

- Use (▶/◀) buttons to move to the desired location.
- Press "Enter" button where you want to mark. You can bookmark up to three scenes.
- Use (▶/◀) buttons to the marked scenes. And press PLAY button on the scene you want.
- Press CLEAR button if you want to delete a marked scene.

NOTE

- This function does not work in a disc which contains multiple camera angles.

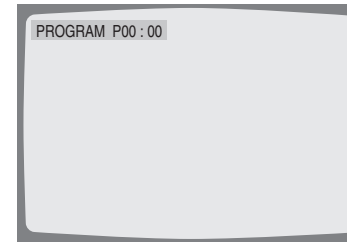

Programming in a specific order

Music can be played in a specific order. Programming is only possible at stop mode.

1 Press PROGRAM button.

- Press the track number using the number buttons.
- Press ENTER button.
- Pressing play button afterwards plays back according to the program.
- A total of 99 songs can be programmed.
- This function is activated for only CD/VCD playback.
- For a VCD version 2.0, this function works only when the PBC is turned off.

NOTE

Instructions on using the number buttons

ex) Inputting track number 25

- Press " 2 " and then " 5 " within 2 seconds.
- For discs that contain less than 25 tracks, pressing " 2 " " 5 " within 2 seconds will input track 2 and track 5.

ex) Inputting track numbers 2 and 5

- Press " 2 " and then " 5 " after 2 seconds.

Deleting a program

- Pressing STOP button during playback of a programmed song will erase that song from the program.
- Pressing CLEAR while programming will delete a song from the program in the reverse order which songs were selected.
- Pressing STOP button while programming will erase the whole program.

Using the setup menu

Pressing SETUP button will show a screen with which various menus can be set. Press SETUP button at stop mode.

Selecting a menu listed on the disc

1 Press MENU button.

- The menu contained in the disc will appear on the screen. The menu appears differently with different discs.
- For a VCD, pressing the menu button will turn on or off PBC.
- This function does not work for a CD.

To create stereophonic sound effects

1 Press 3D button.

- This function lets you enjoy surround effects at stereo mode.

NOTE

- Simulated surround effect does not work with digital audio output (optical/coaxial).

Muting the sound

1 Press MUTE button

- Pressing the button toggles the MUTE function. If no sound is heard with MUTE turned on, turn it off to hear sound.

To view the title menu

1 Press TITLE button

- The title menu contained in the disc will appear. The title menu appears differently with different discs.
- This function will not work with a CD/VCD.

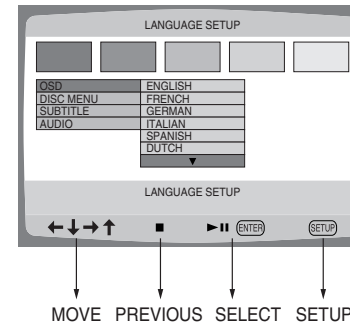

LANGUAGE

- OSD : For selecting a language listed on the display of a DVD
- DISC MENU : For selecting a language listed in a disc.
- SUBTITLE : For selecting subtitle language.
- AUDIO : For selecting audio output language.

VIDEO

- CAPTIONS : For selecting the subtitle language of a VCD.
- SCREEN SAVER : For selecting the screen protection function.

SPEAKER

- DOWN MIX : For selecting effects of the front speakers.
- TEST TONE : For testing speaker output

AUDIO

- DIGITAL OUT : For selecting the digital audio output.
- DUAL MONO : For selecting STEREO MONO sound.
- DYNAMIC RANGE COMPRESSION : For increasing output of the audio only.

CUSTOM

- VFD DISPLAY : For selecting VFD brightness.
- PARENTAL : For selecting allowed viewing/listening level.
- PASSWORD : For setting a password.
- DEFAULTS : For returning all the items to their default values(the factory settings)

To exit SETUP MENU, press SETUP button again.

Setting the language

The language used for on-screen displays, menus contained in the disc, the audio and subtitle can be selected by the following these instructions.

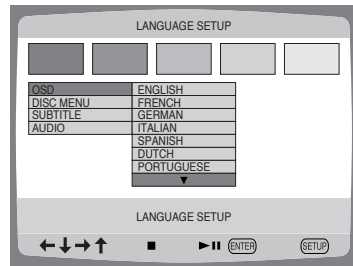

Selecting the on-screen language

- 1 Press SETUP button on the remote controller
- 2 Go to LANGUAGE using the arrow buttons.
- 3 Go to OSD using the arrow buttons.
- 4 Choose the desired language using the arrow buttons and select it by pressing Enter button.

Selecting a menu language contained in the disc

- 1 Press SETUP button on the remote controller.
- 2 Go to LANGUAGE using the arrow buttons.
- 3 Go to DISC MENU using the arrow buttons.
- 4 Choose the desired language using the arrow buttons and select it by pressing Enter button.

NOTE

- This function only works in DISC STOP mode.

Setting the language

Selecting subtitle language

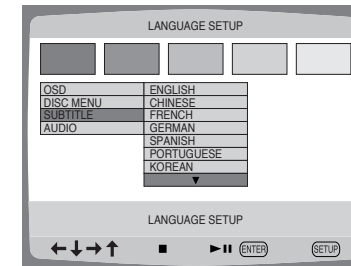

- 1 Press SETUP button on the remote controller.
- 2 Go to "LANGUAGE" using the arrow buttons.
- 3 Go to "SUBTITLE" using the arrow buttons.
- 4 Choose the desired language using the arrow buttons and select it by pressing Enter button.

NOTE

- This function only works in DISC STOP mode.

Selecting audio language

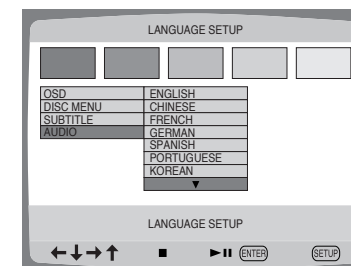

- 1 Press SETUP button on the remote controller.
- 2 Go to "LANGUAGE" using the arrow buttons.
- 3 Go to "AUDIO" using the arrow buttons.
- 4 Choose the desired language using the arrow buttons and select it by pressing Enter button.

NOTE

- If a selected language is not listed in the disc, the language will not appear on the menu.
- This function only works in DISC STOP mode.

Setting the VIDEO

It is set up to the TV connected as follows.

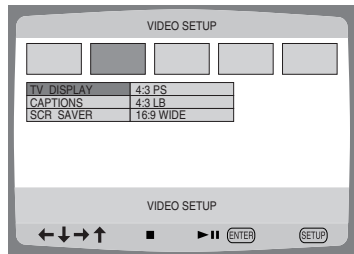

- 1 Press SETUP button on the remote controller.
- 2 Go to VIDEO using the arrow buttons.
- 3 Go to the item using the arrow buttons.
- 4 Choose the desired setting using the arrow buttons and select it by pressing Enter button.

① TV DISPLAY

- 4:3 PAN SCAN : Only the center portion of a 16:9 ratio screen is visible.
- 4:3 LETTER BOX : The complete 16:9 ratio screen is visible with black strips on the top and bottom.
- 16:9 WIDE : For selecting the wide screen TV viewing format.

② CAPTION

- Toggles CAPTION function.
For viewing VCD, subtitles do not initially appear.
- This function will not work with DISCs that do not have subtitles.

③ SCREEN SAVER

- Toggles the screen protection function.

Setting the SPEAKER

Related items of the connected speakers can be selected as follows

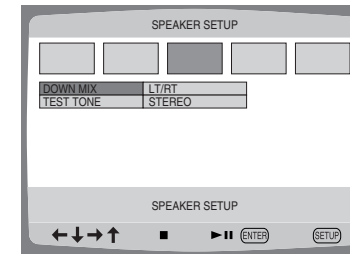

- 1 Press SETUP button on the remote controller.
- 2 Go to SPEAKER using the arrow buttons.
- 3 Go to a desired item using the arrow buttons.
- 4 Choose the desired setting using the arrow buttons and select it by pressing Enter button.

① DOWNMIX

- LT/RT : For selecting surround sound for the front speakers.
- STEREO : For selecting output through the front speakers only.

② TEST TONE

- Activates surround sound test tone for setting speaker levels.

Setting the AUDIO

Audio related items of the connected audio system can be selected as follows.

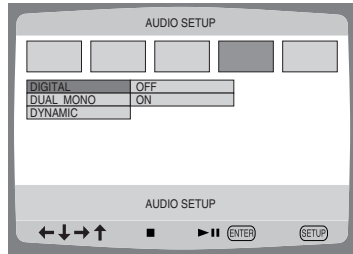

- 1 Press SETUP button on the remote controller.
- 2 Go to AUDIO using the arrow buttons.
- 3 Go to a desired item using the arrow buttons.
- 4 Choose the desired setting using the arrow buttons and select it by pressing Enter button.

1 DIGITAL OUT

- OFF : set to disconnect the digital output sound
- ON : set to output digital sound

2 DUAL MONO

- STEREO : For stereo sound output.
- LEFT MONO : For selecting the output of the left channel of the audio track.
- RIGHT MONO : For selecting the output of the right channel of the audio track.
- MIXED MONO : For selecting the output of both the left and right channels of the audio track.

3 DYNAMIC RANGE COMPRESSION

- For increasing the output of the audio only (FULL, 3/4, 2/4, 1/4, OFF)
- Selecting OFF returns to the default value.

CUSTOM settings

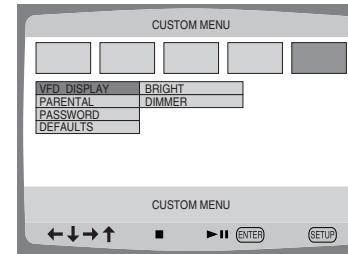

- 1 Press SETUP button on the remote controller.
- 2 Go to "CUSTOM" using the arrow buttons.
- 3 Go to a desired item using the arrow buttons.
- 4 Choose the desired setting using the arrow buttons and select it by pressing Enter button.

1 VFD DISPLAY

- BRIGHT : Turn on the display panel
- DIMMER : Darken the display panel

2 PARENTAL

- Set a password and select rating level for DVDs unsuitable for children. For more details, turn to page 33.

3 PASSWORD

- Turn to page 33 for more details.

4 DEFAULTS

- Return to the factory settings.

Repeat playback

1 Pressing REPEAT button at playback or stop Mode will go through the settings in the following order:
REPEAT TRACK → REPEAT DISC
→ REPEAT OFF

- REPEAT TRACK : Repeated playback of only the current song
- REPEAT DISC : Repeat playback of all the songs in DISC
- REPEAT OFF : Turn off repeated playback.

Skipping a Track

1 Pressing ►► button skips the current track to the next.

2 Pressing ◀◀ button jumps to the beginning of the current track and pressing it again skips to the previous.

Muting the sound

1 Press MUTE button.
Pressing the button toggles between MUTE ON and MUTE OFF.

- MUTE : Select for no audio output.
- MUTE OFF : Select for audio output.

To create 3D surround effects

1 Press 3D button.

- Pressing the button will toggle the surround sound function

NOTE

- Simulated surround effect does not work at digital audio output (optical/coaxial).

Initial settings

- Pressing SETUP button displays a screen where various menus can be set beforehand.
- For more details, turn to page 26.

Accessories



User's Manual

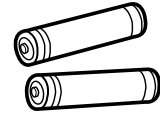

Batteries (2 AA size batteries)



Remote controller

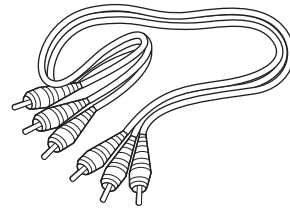

1 Audio/video connection cable

Install Batteries in the Remote

- 1** Remove the battery Compartment cover
- 2** Insert two 'AA' Alkaline batteries make sure that the batteries are inserted with their positive \oplus and negative \ominus poles positioned correctly.
- 3** Close the cover until it clicks

If remote doesn't operate properly:

- Check the polarity + - of the batteries (Dry-Cell)
- Check if the batteries are drained.
- Check if remote sensor is blocked by obstacles.
- Check if there is any fluorescent lighting nearby.

Check the following guide for the possible cause of a problem before contacting service.

Symptom	Cause	Correction
No power.	• The power cord is disconnected.	• Plug the power cord into the wall outlet securely.
The power is on, but the DVD player does not work.	• No disc is inserted.	• Insert a disc. (Check that the DVD or, audio CD indicator in the DVD display is lit.)
No picture.	• The TV is not set to receive DVD signal output	• Select the appropriate video input mode on the TV so the picture from the DVD player appears on the TV screen.
	• The video cable is not connected securely.	• Connect the video cable into the jacks securely.
	• The connected TV power is turned off.	• Turn on the TV.
No sound.	• The equipment connected with the audio cable is not set to receive DVD signal output.	• Select the correct input mode of the audio receiver so you can listen to the sound from the DVD player.
	• The audio cables are not connected securely.	• Connect the audio cable into the jacks securely.
	• The power of the equipment connected with the audio cable is turned off.	• Turn on the equipment connected with the audio cable.
	• The digital Audio Output is set to the wrong position.	• Set the Digital Audio Output to the correct position, then turn on the DVD player again by pressing the POWER button.
The playback picture is poor.	• The disc is dirty.	• Clean the disc.
The DVD player does not start playback.	• No disc is inserted.	• Insert a disc. (Check that the DVD, or audio CD indicator in the DVD display is lit.)
	• An unplayable disc is inserted.	• Insert a playable disc. (Check the disc type, color system and Regional code.)
	• The disc is placed upside down.	• Place the disc with the playback side down.
	• The disc is not placed within the guide.	• Place the disc on the disc tray correctly inside the guide.
	• The disc is dirty.	• Clean the disc.
	• A menu is on the TV screen.	• Press the SETUP button to turn off the menu screen.
	• The Rating level is set.	• Cancel the Rating function or change the rating level.
The remote control does not work properly.	• The remote control is not pointed at the remote sensor of the DVD player.	• Point the remote control at the remote sensor of the DVD player.
	• The remote control is too far from the DVD player.	• Operate the remote control within about 23 ft (7m).
	• There is an obstacle in the path of the remote control and the DVD player.	• Remove the obstacle.
	• The batteries in the remote control are exhausted.	• Replace the batteries with new ones.

Specifications

General	Power supply	AC/CA 120V ~ 60Hz
	Power consumption	14 W
	Exterior dimensions(LxHxD)	430 X 260 X 80
	Weight	3.2 Kg
	Safe operation temperature	5°C ~ 40°C
	Safe operation humidity	10% ~ 75% RH
VIDEO	VIDEO OUT	1V max (at 75ohm load)
	S-VIDEO OUT	Luminance signal(Y) : 0.7V max (at 75 ohm load) Color signal(C) : 0.286V max (at 75ohm load)
	SCART(OPTION)	COMPONENT : 0.7V max (at 75ohm load)
AUDIO	Frequency Respense	DVD : 48KHz 4Hz ~ 22KHz 96KHz 4Hz ~ 44KHz VCD : 44.1KHz 4Hz ~ 20KHz CD : 44.1KHz 4Hz ~ 20KHz
		ANALOG 2CH : 2.0Vrms(1KHz) max DIGITAL : 1.15V max

※ Designs and specifications are subject to change without notice.